

MAXI-LIFT



OTHER PRODUCTS & ACCESSORIES

UPGRADE TO THE
TOUGHEST ACCESSORIES

- **SPLICES, BOLTS,
HARDWARE
& ACCESSORIES**
- **PULLEYS, LAGGING &
HANGER BEARINGS**
- **MIGHTY-MAX
FENCE FEEDERS**

MAXI-LIFT



BELT SPLICES: MAXI-SPLICE SUPER® & ULTRA®

Super Strength, Ultra-Light

ULTRA & SUPER SPLICES

THE PERFECT COMBINATION OF SUPER-STRONG & ULTRA-LIGHT.

THE PERFECT COMBO

HEAVY DUTY ELEVATOR?

THE "SUPER" IS IDEAL FOR BELTS BETWEEN 800-1200 PIW

THE "ULTRA" FITS PERFECTLY ON BELTS UP TO 800 PIW.

SUPER-STRONG

THE SUPER & ULTRA ARE CONSTRUCTED OF HIGH GRADE ALUMINUM, NBR RUBBER WEDGES & SS BOLTS

ULTRA-PERFORMANCE

ULTRA & SUPER ARE ENGINEERED TO OUT-PERFORM TRADITIONAL SPLICES

FEATURES & BENEFITS

- Large Radius for Heavy Belts
- High Grade Aluminum Construction
- Non Sparking / Corrosion Resistant
- NBR Rubber Wedges (High Temp Options Available for Bottom Wedge)



MAXI-SPLICE®
SUPER

MAXI-SPLICE®
ULTRA



Interlocking Teeth Grip Belt



Heavy Duty Bolts



3-Piece Construction



NBR Rubber Wedge

MAXI-SPLICE SUPER® & ULTRA®

Call 1-800-527-0657, Visit MAXILIFT.COM for More Info

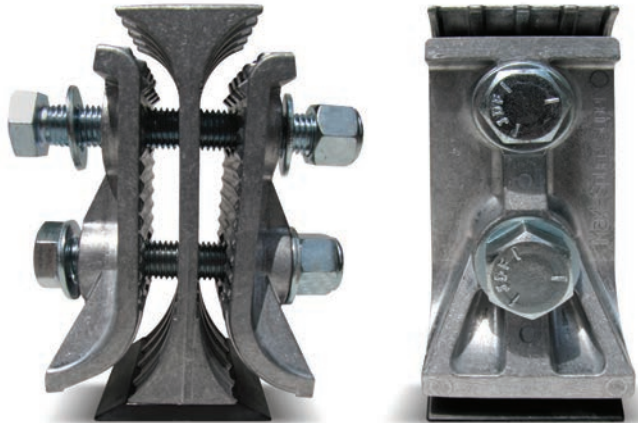

MAXI-SPLICE
SUPER

MAXI-SPLICE SUPER

Named for its superior design, performance and size, the **MAXI-SPLICE SUPER** (along with its counterpart the **MAXI-SPLICE ULTRA**) defines the next generation of elevator belt splices. The unique design embraces our **MAXI-SPLICE** three piece construction, with the addition of an NBR rubber wedge to protect against belt wear for long life. Designed with a larger radius for improved belt life, the larger **SUPER** has two bolts for additional clamping force and plate friction. See Specifications on Page 87.

FEATURES

- High Grade, Lightweight Aluminum Construction
- NBR Rubber Wedge Protects Backside of Belt
- High Temp Options Available for Bottom Wedge
- Weight: 4.8 lbs. each
- Two Bolt Design
- 3/4" x 5" and 3/4" x 5-1/2" Hex Head Bolts
- Usable on Belts Rated 800-1200 PIW tensile.



MAXI-SPLICE
ULTRA

MAXI-SPLICE ULTRA

The aptly named **MAXI-SPLICE ULTRA** is perfect companion to the larger **SUPER**. The **ULTRA** features all the advantages of the larger splice, but with a smaller frame and a single bolt design. Designed for belts up to 800 PIW, the **ULTRA** also features the **MAXI-SPLICE** three piece construction and NBR rubber wedge for protection against belt wear and longer life. Like the **SUPER**, the **ULTRA** is designed with a larger radius for improved belt life. See Specifications on Page 87.

FEATURES

- High Grade, Lightweight Aluminum Construction
- NBR Rubber Wedge Protects Backside of Belt
- High Temp Options Available for Bottom Wedge
- Weight: 1.93 lbs. each
- One Bolt Design
- 5/8" x 4-1/2" Hex Head Bolt
- Rated for belts up to 800 PIW



BELT SPLICES: MAXI-SPLICE® AB & CI

For More Information, Call 1-800-527-0657



MAXI-SPLICE® AB

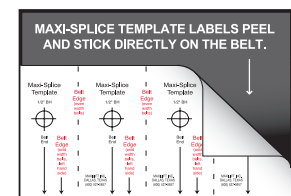
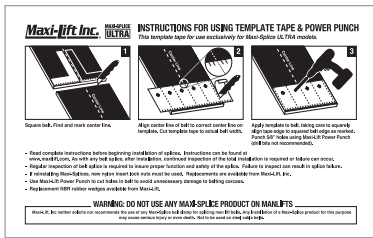

ILLUSTRATION DEPICTS USAGE ON AN 8 INCH BELT.



MAXI-SPLICE Belt Fastening Systems

Maxi-Splice is a 3-piece elevator belt splicing device. Trusted for over 30 years, it sets the standard for all who hope to copy it. Make sure you ask for Maxi-Splice by name, and accept no substitutes. For use on PVC and rubber elevator belts. See Specifications on Page 87.

MAXI-SPLICE AB

- 9/16" Diameter Grade 5 Bolt
- 9/16" x 5" Hex Head Bolts
- Non-Ferrous Metal of Very High Tensile Strength
- Usable On Belts of up to 800 PIW Tensile
- Non-Sparking, Non-Corroding & Non-Rusting
- Bronze Color
- Weight: 2.9 Lbs. Each

MAXI-SPLICE CI

- Ferrous Metal of Moderately High Tensile Strength
- 1/2" x 5" Hex Head Bolts
- Usable on Belts of Up to 600 PIW Tensile
- Silver Color
- Weight: 2.6 Lbs. Each

TEMPLATE TAPE - FREE

- Peel and stick directly on belt
- Improves belt-punching accuracy
- Marks hole locations for odd or even width belts
- Clearly marked in white and red lettering
- Included with every splice order

POWER PUNCH *(Drill bits are not recommended)*

- Made with durable heat treated carbon-steel
- Reinforced blade easily cuts 1/2", 9/16", 5/8" and 3/4" diameter holes
- Sized to match your exact splice
- Use with a hand-held mallet, impact wrench, or drill
- Always wear eye protection



WARNING: DO NOT USE MAXI-SPLICE ON MANLIFTS!

Please read all instructions before installing any Maxi-Splice product. Instructions can be found at www.maxilift.com. Failure to follow installation instructions may result in splice failure. As with any belt splice, continuous, regular inspections are required or failure can occur.

Never mix Maxi-Splice products on a single installation. Reduced or uneven clamping pressure may occur compromising splice integrity and could result in splice failure.

Maxi-Lift neither solicits nor recommends the use of any Maxi-Splice belt clamp for splicing man-lift belts. Maxi-Splices were neither designed for nor tested for this purpose. Any installation of a Maxi-Splice product for this purpose may result in splice failure causing serious bodily harm or even death. Do not use on steel cable belts.

Do not re-use nylon insert lock nuts when reinstalling Maxi-Splices. Please use new nylock nuts for reinstallation. Replacements are available from Maxi-Lift.

For applications exceeding 250° F, nylon insert lock nuts may not be used, as this temperature range exceeds the manufacturer's threshold for nylon integrity. Compression locking nuts should be utilized instead.

While the AB and CI Maxi-Splice may be used on wing pulleys, they may contribute to wear on the backside of the belt at the splice. It is the user's responsibility to inspect the splice at regular maintenance intervals to prevent failure. Noise may also be heard as the splice contacts the wings of the pulley.

MAXI-LIFT BELT SPLICES

Splice Comparison

BELT SPLICE TECHNICAL DATA SHEET

											
		MAXI-SPLICE [®]	MAXI-SPLICE [®]	MAXI-SPLICE [®]	MAXI-SPLICE [®]	MAXI-SPLICE [®]	MAXI-SPLICE [®]	MAXI-SPLICE [®]	MAXI-SPLICE [®]		
PART DETAILS	Product	MAXI-SPLICE	MAXI-SPLICE	MAXI-SPLICE	MAXI-SPLICE	MAXI-SPLICE	MAXI-SPLICE	MAXI-SPLICE			
	Brand	CI	AB	ULTRA	SUPER	TITAN					
	Part No.	CI5	AB5	ULTRA5	SUPER5	TITAN					
SPLICE CONSTRUCTION	Color	Silver	Manganese Bronze	Silver	Silver	Silver					
	Construction	3 Piece Mechanical Clamping Device	3 Piece Mechanical Clamping Device	3 Piece Mechanical Clamping Device with NBR (Nitrile) Rubber Wedge	3 Piece Mechanical Clamping Device with NBR (Nitrile) Rubber Wedge	3 Piece Mechanical Clamping Device with HNBR Rubber Wedge					
	Metal Material	Galvanized Cast Iron	Manganese Bronze	Aluminum	Aluminum	Aluminum					
	Metal Description	Ferrous Cast Iron	Non-Ferrous Bronze	High Grade, Lightweight Aluminum	High Grade, Lightweight Aluminum	High Grade, Lightweight Aluminum					
	Rubber Material	None	None	Replaceable NBR Rubber Wedge	Replaceable NBR Rubber Wedge	Replaceable HNBR Rubber Wedge					
SPLICE SPECIFICATIONS	Weight (lbs.)	2.60	2.90	1.93	4.80	Per Application					
	Length	3"	3"	4-1/2"	6-1/4"	6"					
	Width	2"	2"	2-1/2"	3"	Per Application					
	PIW Rated	Up to 600 PIW Tensile	Up to 800 PIW Tensile	Up to 800 PIW Tensile	800-1200 PIW Tensile	Over 1200 PIW					
	Recommended Belt Thickness	1/4" to 5/8"	1/4" to 5/8"	1/4" to 5/8"	3/8" to 3/4"	Per Application					
BOLT SPECIFICATIONS	No of Bolts	1	1	1	2	Per Application					
	Bolt Grade	Grade 5 Hex Head Bolt	Grade 5 Hex Head Bolt	Grade 5 Hex Head Bolt	Grade 5 Hex Head Bolt	M16 10.9 Hex Head Bolt					
	Bolt Diameter (Inches)	1/2"	9/16"	5/8"	3/4"	Per Application					
	Bolt Length (Inches)	5"	5"	4-1/2"	5" and 5-1/2"	Per Application					
	Washers	Yes	Yes	Yes	Yes	Yes					
	Nuts	Nylock	Nylock	Nylock	Nylock	Oval Lock Nut					
	Recommended Torque *	75 ft./lbs.	100 ft./lbs.	125 ft./lbs.	150 ft./lbs.	Per Application					
Template Tape Included	Yes	Yes	Yes	Yes	Requires Special Template						
SHIMS	Required Shims Per Belt Thickness	N/A	N/A	Under 5/16" - No Shims 5/16" to 3/8" - 1 Shim 3/8" to 5/8" - 2 Shims	Under 1/2" - No Shims 1/2" to 5/8" - 1 Shim 5/8" to 3/4" - 2 Shims	N/A					
TEMPERATURE RATINGS	Max. Operating Temps	600° F / 350° C	500° F / 260° C	200° F / 93° C (NBR Rubber Wedge Limiting Factor) - Alternative Wedges Available for Higher Temperatures	200° F / 93° C (NBR Rubber Wedge Limiting Factor) - Alternative Wedges Available for Higher Temperatures	320° F / 160° C (HNBR Hydrogenated Nitrile Butadiene Rubber Wedge Limiting Factor)					
	Nylock Nut Max. Temp	250° F	250° F	250° F	250° F	320° F					
MINIMUM HEAD PULLEY	Agricultural (High Speed) **	12"	12"	24"	30"	48"					
	Industrial (Centrifugal/Gravity)	12"	12"	20"	36"	48"					
BUCKET PROJECTION	Minimum Recommended	4"	4"	5"	7"	8"					
FEATURES/BENEFITS		Strong, Standard, Mechanical Splice	Non-Sparking, Non-Corroding, Non-Rusting	Non-Sparking, Non-Corroding, Non-Rusting, Longer Belt Life	Non-Sparking, Non-Corroding, Non-Rusting, Longer Belt Life	Non-Sparking, Non-Corroding, Non-Rusting, Longer Belt Life					

* When torquing splice bolts, do not use impact wrench as over-torquing will cause both belt and splice failure. In addition, under torquing could lead to insufficient clamp pressure and could create splice failure, and tracking issues. ** On smaller pulleys, the metal shims must be installed correctly, or the rubber wedge could fail. Customer is responsible for checking the splices on a consistent basis for correct torque during splice operation. Do not reuse hardware (bolts, nylock or oval nuts) when reinstalling splices. Please always read Maxi-Lift Installation Instructions and apply template tape when installing splices for correct installation. See website for more details. Do not use Maxi-Lift splices on any type of belt manlifts.

U.S. Utility Patent: "U.S. Pat. 9,605,730 B2. U.S. Design Patent: "U.S. Des. Pat. D724,289 S. European Patent Application No. 15154390.7

ELEVATOR BOLTS

Same Day Shipping Available

STANDARD ELEVATOR BOLT

Standard #1 Norway
• Zinc Plated
(Carbon, Stainless Steel
offered in select sizes)

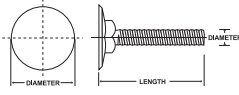

STANDARD ELEVATOR BOLT			
SIZE, INCHES	WEIGHT / 100 PCS., LBS.	CASE QTY	KEG BULK QTY
1/4 x 1	3.24	1200	1700
1/4 x 1-1/4	3.43	1200	1500
1/4 x 1-1/2	3.73	1200	1300
1/4 x 1-3/4	3.98	1200	1200
1/4 x 2	4.29	1200	1000
1/4 x 2-1/4	4.88	600	900
1/4 x 2-1/2	4.92	600	800
5/16 x 3/4	4.76	1200	1200
5/16 x 1-1/4	5.55	1200	900
5/16 x 1-1/2	6.38	600	800
5/16 x 1-3/4	6.50	600	700
5/16 x 2	7.12	600	600
5/16 x 2-1/4	7.43	600	550
5/16 x 2-1/2	7.78	600	500
3/8 x 1-1/4	6.54	600	750
3/8 x 1-1/2	7.10	600	700
3/8 x 1-3/4	7.66	600	600
3/8 x 2	8.31	600	500
3/8 x 2-1/4	9.35	600	450
3/8 x 2-1/2	9.83	600	400
3/8 x 3	10.79	600	300

SABRE-TOOTH® ELEVATOR BOLT

Sabre-Tooth®
• Zinc Plated
(Carbon, Stainless Steel
offered in select sizes)

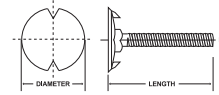

SABRE-TOOTH ELEVATOR BOLT			
SIZE, INCHES	WEIGHT / 100 PCS., LBS.	CASE QTY	KEG BULK QTY
1/4 x 3/4	2.94	1200	2000
1/4 x 1	3.24	1200	1700
1/4 x 1-1/4	3.43	1200	1500
1/4 x 1-1/2	3.73	1200	1300
1/4 x 1-3/4	3.98	1200	1200
1/4 x 2	4.29	1200	1000
1/4 x 2-1/4	4.88	600	900
1/4 x 2-1/2	4.92	600	800
5/16 x 3/4	4.76	1200	1200
5/16 x 1	5.05	1200	1000
5/16 x 1-1/4	5.55	1200	900
5/16 x 1-1/2	6.38	600	800
5/16 x 1-3/4	6.50	600	700
5/16 x 2	7.12	600	600
5/16 x 2-1/4	7.43	600	550
5/16 x 2-1/2	7.78	600	500
3/8 x 1-1/4	6.54	600	750
3/8 x 1-1/2	7.10	600	700
3/8 x 1-3/4	7.66	600	600
3/8 x 2	8.31	600	500
3/8 x 2-1/4	9.35	600	450
3/8 x 2-1/2	9.83	600	400
3/8 x 3	10.79	600	300

RELIANCE ELEVATOR BOLT

#3 Slotted Head
• Zinc Plated

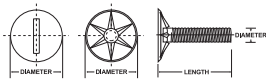

RELIANCE ELEVATOR BOLT			
SIZE, INCHES	WEIGHT / 100 PCS., LBS.	CASE QTY	KEG BULK QTY
1/4 x 3/4	2.7	1200	2400
1/4 x 1	1.9	1800	2500
1/4 x 1-1/4	3.0	1200	1800
1/4 x 1-1/2	3.5	1200	1800
5/16 x 1-1/4	4.9	1200	1200

SABRE-TOOTH® BOLT (POINTED)

Sabre-Tooth®
• Carbon Steel

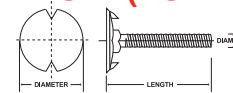

SABRE-TOOTH ELEVATOR BOLT			
SIZE, INCHES	WEIGHT / 100 PCS., LBS.	CASE QTY	KEG BULK QTY
1/4 x 1-1/2	2.78	1300	1800
5/16 X 1-1/4	4.60	900	1200

HEX HEAD BOLT

• Zinc Plated
• Grade 5
• Used with Chain Attachments

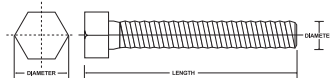

HEX-HEAD BOLT			
SIZE, INCHES	WEIGHT / 100 PCS., LBS.	CASE QTY	KEG BULK QTY
1/2 X 1	8.50	1200	1700
1/2 x 1-1/4	9.45	1200	1500
1/2 x 1-1/2	10.70	1200	1300
3/8 x 1	4.15	1200	1700
3/8 x 1-1/4	4.80	1200	1500
3/8 x 1-1/2	5.65	1200	1300

Maxi-Lift continually applies metallography tests to our fasteners to ensure the finest quality parts are upheld.

Maxi-Lift exceeds all industry standards for grade 2 elevator bolts.

WASHERS, NUTS & SPACERS

Call 1-800-527-0657, Visit MAXILIFT.COM for More Info

NUTS

STANDARD HEX		SIZE, INCHES (ID)	PKG. QTY., PCS.	PKG. WEIGHT, LBS.
		1/4-20	100	0.7
		5/16-18	100	1.1
		3/8-16	100	1.6
	<i>Available in zinc and stainless.</i>	1/2	100	3.8

STANDARD FLANGE SERRATED LOCK		SIZE, INCHES (ID)	PKG. QTY., PCS.	PKG. WEIGHT, LBS.
		1/4-20	100	0.9
		5/16-18	100	1.2
		3/8-16	100	1.8
	<i>Available in zinc and stainless.</i>			

LARGE FLANGE SERRATED LOCK		SIZE, INCHES (ID)	PKG. QTY., PCS.	PKG. WEIGHT, LBS.
		1/4-20	100	1.2
		5/16-18	100	2.3
		3/8-16	100	2.8
	<i>Available in zinc.</i>			

NYLON INSERT LOCK		SIZE, INCHES (ID)	PKG. QTY., PCS.	PKG. WEIGHT, LBS.
		1/4-20	100	0.8
		5/16-18	100	1.1
		3/8-16	100	2.8
	<i>Available in zinc and stainless.</i>			

RECOMMENDED BUCKET INSTALLATION

A locking device should be used on all elevator bucket installations.

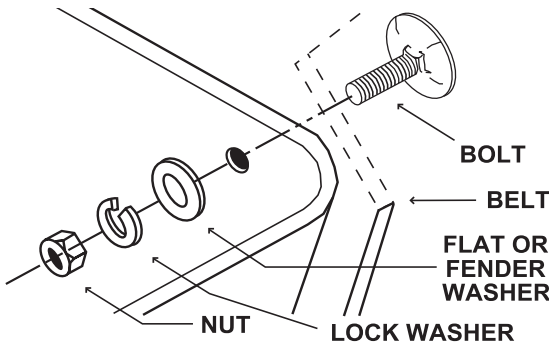



DIRECTIONS FOR PROPER ELEVATOR BOLT TORQUE ON BELT

1. To tighten the nuts, use a torque wrench that will "click" out when proper setting is reached.
2. Run the elevator with the buckets empty for 4 hours.
3. Check all bolts to insure that the proper torque is maintained.

WASHERS AND SPACERS

FLAT		SIZE, INCHES (ID)	PKG. QTY., PCS.	PKG. WEIGHT, LBS.	O.D. INCHES
		1/4	100	1.3	1
		5/16	100	2.0	7/8
		3/8	100	3.0	1
	<i>Available in zinc and stainless.</i>	1/2	100	3.8	1-3/8

SPLIT RING LOCK		SIZE, INCHES (ID)	PKG. QTY., PCS.	PKG. WEIGHT, LBS.	O.D. INCHES
		1/4	100	0.2	1-1/4
		5/16	100	0.4	7/8
		3/8	100	0.6	1
	<i>Available in zinc and stainless.</i>	1/2	100	1.4	1-3/8

FENDER*		SIZE, INCHES (ID)	PKG. QTY., PCS.	PKG. WEIGHT, LBS.	O.D. INCHES
		1/4	100	1.3	1
		Large 1/4	100	1.3	1-1/4
		5/16	100	2.0	1-1/4
		Large 5/16	100	3.0	1-1/2
		3/8	100	3.0	1
		1/2	100	3.8	1-3/8
	<i>Available in zinc and stainless.</i>				

*When installing urethane buckets always use Fender Washers.

LEATHER		SIZE, INCHES (ID)	PKG. QTY., PCS.	PKG. WEIGHT, LBS.	O.D. INCHES
		1/4	100	0.3	1
		5/16	100	0.3	1
		3/8	100	0.3	1

POLY SPACERS		SIZE, INCHES (ID)	PKG. QTY., PCS.	PKG. WEIGHT, LBS.	O.D. INCHES
		1/4	100	2.0	-
		5/16	100	1.8	-
	<i>Available in 1/4" and 1/2" thick.</i>				

NEOPRENE		SIZE, INCHES (ID)	PKG. QTY., PCS.	PKG. WEIGHT, LBS.	O.D. INCHES
		1/4	100	1.1	-
		5/16	100	1.1	-
		3/8	100	1.1	-
	<i>Available in 1/4" thick.</i>				

RECOMMENDED TORQUE FOR ELEVATOR BOLTS						
SHANK DIAMETER	STEEL			STAINLESS		
	IN./LBS.	KGM/M.	FT./LBS.	IN./LBS.	KGM/M.	FT./LBS.
1/4"	50	0.57	4	86	.99	7.16
5/16"	96	1.10	8	177	2.04	14.75
3/8"	180	2.07	15	-	-	-

PULLEYS & LAGGING

High Performance Elevator Lagging & Pulleys

PULLEYS & LAGGING

Maxi-Lift Elevator Pulleys feature a continuous weld of the disc to the rim, coupled with heavy duty construction and a high compression hub and bushing, single disc pulley capable of reducing stress and deflection, the most common effects of pulley fatigue. Pulleys are constructed with a standard crown face and XT® hubs unless otherwise specified.

Maxi-Lift Lagging / Traction Pads with neoprene, 60 durometer, static conductive, oil resistant and flame resistant (SOF) rubber compound for use on drive pulleys, in 72" lengths, formed to specific pulley diameters. Also available in standard rubber or special compounds with standard or stainless steel (SS) backing plates.

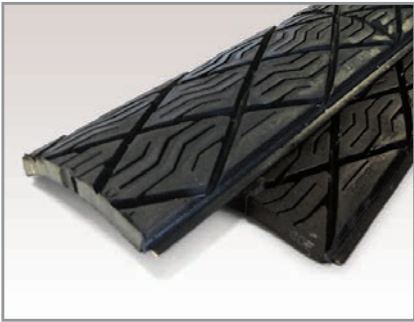

SOF & Standard Lagging

Agricultural Applications, SOF - Oil Resistant, Static Resistant (OSHA compliant), Flame Resistant (MSHA compliant)

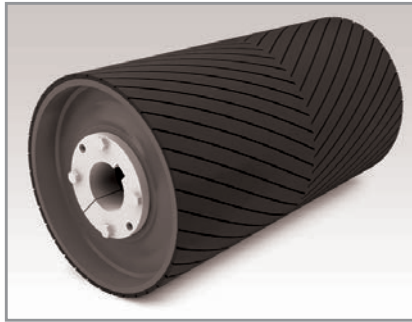

Pulley w/ Lagging

Available in Heavy Duty, Mine Duty, and Pro Duty

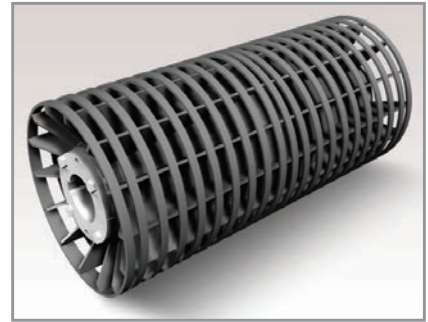

Spiral Wing Pulley

Available in Heavy Duty, Mine Duty, and Pro Duty

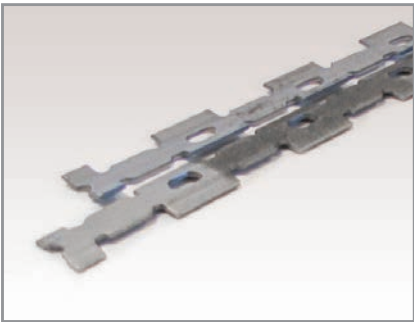

Metal Retainers

Rust Resistant

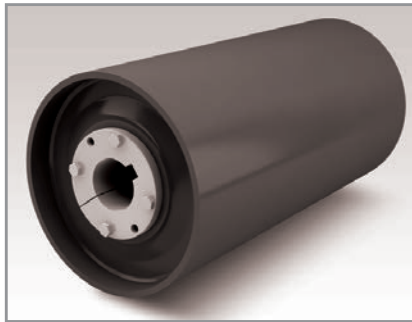

Pulley (no Lagging)

Available in Heavy Duty, Mine Duty, and Pro Duty

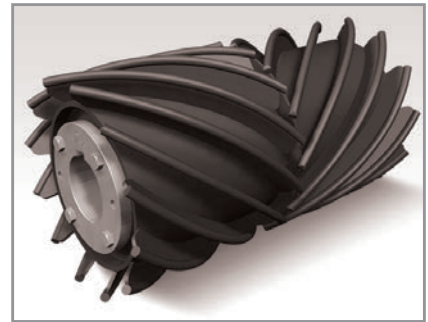

Herringbone Wing Pulley

Available in Heavy Duty, Mine Duty, and Pro Duty

* Other sizes available on request. Please contact Maxi-Lift for information on product sizes, pricing and availability.

HANGER BEARINGS

For Screw Conveyors

SCREW CONVEYOR HANGER BEARINGS

STYLE "A" BEARING: STYLE 226

Two-piece double flange bearing for screw conveyor hanger with formed strap. This hanger bearing is interchangeable with the following styles: 20A, 20B, 26B, 28A, 30, 50, 220, 226 228 and 326.



STYLE A: DIMENSIONS				
A	B	C	D	E
1-1/2	2-3/16	2-1/2	1-7/8	1-9/16
2	2-3/4	3-1/8	1-15/16	1-9/16
2-7/16	3-1/4	3-11/16	2-15/16	2-3/8
3	4	4-3/8	2-15/16	2-1/4
3-7/16	4-3/4	5	3-3/16	3-1/16

* Tolerances: + 1/16" / - 0"

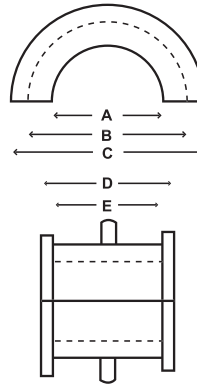
Other sizes available on request. Hanger strap not included.



AVAILABLE MATERIALS

	PLASTECH	WEARITE*	UHMW
MAXI-LIFT HANGER BEARINGS			
MATERIAL	Engineered Nylon Resin	Engineered Nylon Resin	Polyethylene
GRADE	Food Grade, FDA	Industrial Grade	Food Grade, FDA
METHOD OF MANUFACTURE	Injection Molded	Injection Molded	Machined Or Molded
TEMPERATURE OPERATING RANGE	-60°F To +300°F	-60°F To +300°F	-22°F To +180°F
LUBRICANT	Built-In Lubricant	Built-In Lubricant*	Natural
COLOR	Tan	Black	White

* Wearite bearings available drilled and tapped for lubing or purging pipes at additional cost.

MIGHTY-MAX® FENCE FEEDERS

Tough, Portable Plastic Feeders

MIGHTY-MAX® FENCE FEEDERS

Portable, easy to install, and tough, the **MIGHTY-MAX** fence feeder is the most versatile livestock feeder on the market. Quickly and securely snaps onto any chain-link or wire fencing. Built with two spring link clips installed on a super tough HDPE feeder, it can take the toughest animal and weather abuse. This is the ideal feeder for show pens, trailers and fenced areas. Keeps feed up off the ground and reduces waste.



STYLE FFSS



STYLE FFCC



STYLE FFHD

FEATURES & BENEFITS

- Made of prime virgin HDPE
- Thick, heavy duty walls
- Extended feeder life
- Tough enough to withstand the harshest animal and weather abuse
- Drilled for and attached with 8mm Spring Link Clips (right)
- Stocked / available in ten (10) standard sizes



ITEM CODE	FEEDER SIZE, INCHES					PUNCHING, IN.				CAP.	WEIGHT, LBS.		QUANTITIES	
	Color	Size	Length	Proj.	Depth	Hole Centers	# Of Holes	Bolt Size	Top Down	Quarts	Lbs. Per Each	Lbs. Per Skid	Carton Qty	Skid Qty
FFSS 09 x 5 P W	White	9 x 5	9-3/8	5-1/4	4-7/8	3-1/4	3	1/4	1	1.0	1.00	420	24	384
FFSS 16 x 7 P W	White	16 x 7	16-3/8	7-3/8	7-1/4	14-3/4	2	3/8	9/16	4.5	2.75	638	12	192
FFHD 10 x 7 P B	Black	10 x 7	10-1/2	7-3/4	7-1/8	8-3/4	2	3/8	9/16	3.5	2.75	784	16	256
FFHD 14 x 7 P B	Black	14 x 7	14-1/2	7-3/4	7-1/8	12-3/4	2	3/8	9/16	5.0	3.35	848	7	112
FFHD 18 x 8 P B	Black	18 x 8	18-1/2	8-3/4	8	16-1/4	2	3/8	9/16	9.0	5.10	810	7	112
FFCC 09 x 5 P G	Gray	9 x 5	9-1/2	5-1/2	5	7-1/2	2	3/8	9/16	1.5	1.20	498	28	448
FFCC 11 x 6 P G	Gray	11 x 6	11-9/16	6-5/8	6	9-9/16	2	3/8	9/16	3.0	1.90	573	13	208
FFCC 14 x 7 P G	Gray	14 x 7	14-9/16	7-7/8	7	12-3/4	2	3/8	9/16	5.0	3.50	848	7	112
FFCC 18 x 8 P G	Gray	18 x 8	18-9/16	8-7/8	8-1/4	16-1/4	2	3/8	9/16	9.0	5.10	810	5	80
FFCC 20 x 8 P G	Gray	20 x 8	20-9/16	8-7/8	8-1/4	18-9/16	2	3/8	9/16	10.0	6.10	792	5	80

